

Process Compensated Resonance Testing JT8D-219 1st Stage Blades

September 24th, 2008

David
Piotrowski
Principal Engineer
ASNT LEVEL III UT, PT, ET



Lem Hunter
President

Trista Sloan
Application Engineer



OUTLINE OF PRESENTATION

- Background/History
- PCRT Overview
- Test plan
- PCRT Project to Date
- PCRT – Overtemp
 - Preliminary Results
- PCRT – IGA/Stress Rupture
 - Preliminary Results
- PCRT – Thin wall/cracking
 - Preliminary Results
- Work to be done
- Summary



BACKGROUND/HISTORY OF JT8D 1ST STAGE TB



- In service failures caused by:
 - Overtemp
 - IGA
 - Thin wall
 - Stress rupture
- Over 150 blade fracture events reported by P&W since 1990
- Only inspections are UT wall thickness, visual/dimensional/FPI for cracking
- Poor method of determining if over-temped
 - 1/64 blades sectioned per P&W manual
- No practical inspection for IGA
- 24,000 cycle limit and 2-strip limit to avoid future failures
 - No lifetime tracking
 - Not a serialized component,
 - Service markings are inconsistent

Need an improved NDT method!!!

JT8D 1st Stage Blades are cause of UER and in-service failures

PCRT OVERVIEW

PCRT System uses resonance spectra and complex algorithms to correctly sort acceptable from unacceptable parts

Resonant Frequencies determined by dimensions and material properties of “whole part”

$$f_r \sim \sqrt{k/m}$$

f_r = resonant frequency

k = stiffness (elastic properties e.g., Young’s Modulus)

m = mass (dimensions, density)

Structural Defect = Strength reduction caused by degraded material properties or dimensional variation

e.g., a crack reduces stiffness and lowers the resonant frequency

Degree of resonant frequency shift is proportional to the severity of the defect

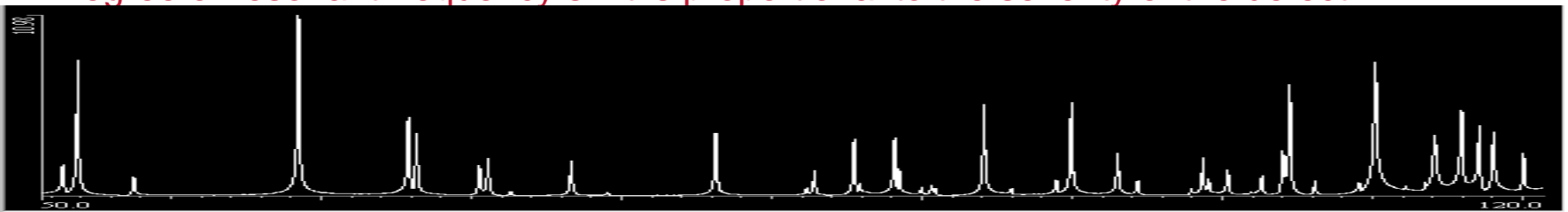

Resonance Spectra

Use of PCRT can significantly reduce inspection time

PCRT OVERVIEW cont.

Simple resonance analysis is insufficient for defect detection since unacceptable and acceptable patterns are interlaced

PCRT calculations MTS (Mahalanobis-Taguchi System) characterizes acceptable parts & variation and a Bias score characterizes unacceptable parts

PCRT System Hardware

- Simple part interface, PZT transducers
- Precision spectrum analyzer & signal generator

PCRT System Software

- PC computing power
- Statistical analysis with Mahalanobis-Taguchi
- Vibrational pattern recognition algorithms
- Digital storage of spectra

PCRT Strengths

- Rigid, Hard Components
- Characterizing Mature, Well-Controlled Manufacturing Processes
- Sorting for Structural Integrity with a Single, Whole Body Test for Multiple Defect Sources
- Digital Historical Record of Resonant Spectra for Life-of-Part Surveillance
- Elimination of Operator Error

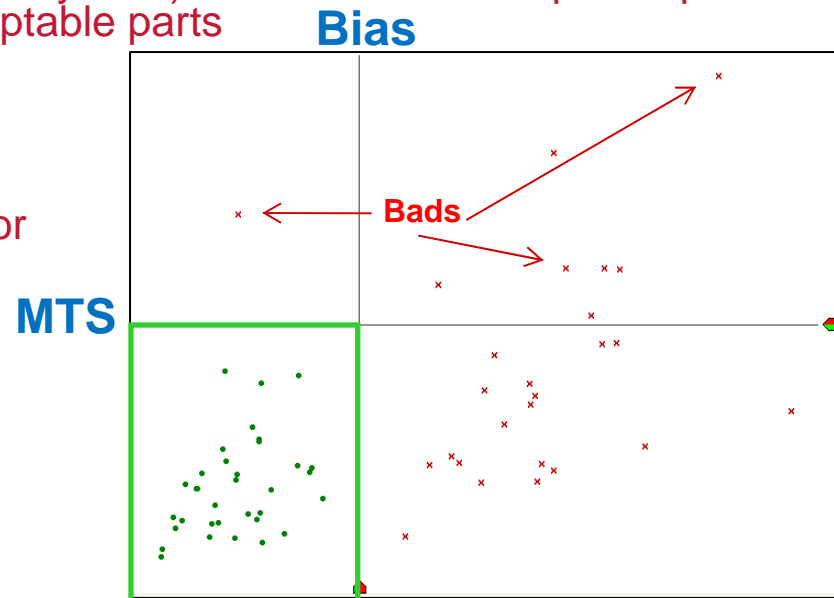

Use of PCRT can significantly increase inspection confidence

PROJECT TEST PLAN

- Probability of Detection (POD) for each defect type must be accounted for
- Each blade could contain none, some, or all defects

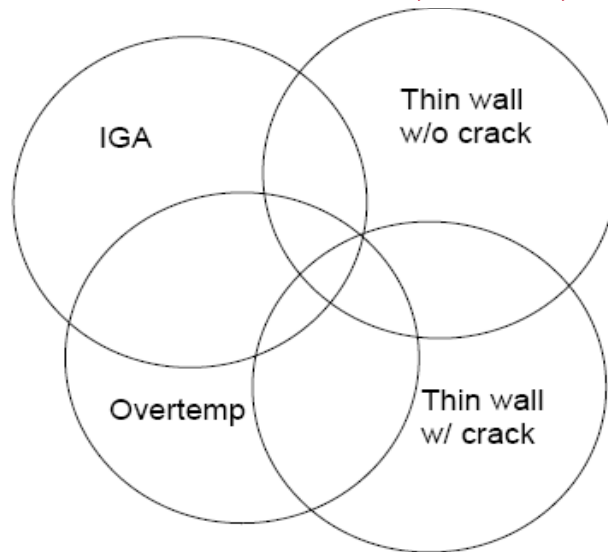

Goals

Near term:
Supplemental Insp
to reduce pain

Far term:
AMOC

- Total POD will be a combination of individual POD values for thin wall with cracking, thin wall without cracking, IGA, and overtemps:

$$\text{COMBINED POD} = 1 - \{(1 - P_{OT}) (1 - P_{TW/C}) (1 - P_{TW/NC}) (1 - P_{IGA})\}$$

Where P_{OT} = the POD of an over-temperature condition, $P_{TW/C}$ = the POD of thin wall with cracking, $P_{TW/NC}$ = POD of thin wall without cracking, and P_{IGA} = the POD of intergranular corrosion attack.

Individual and combined PODs planned

PROJECT TEST PLAN CONT.

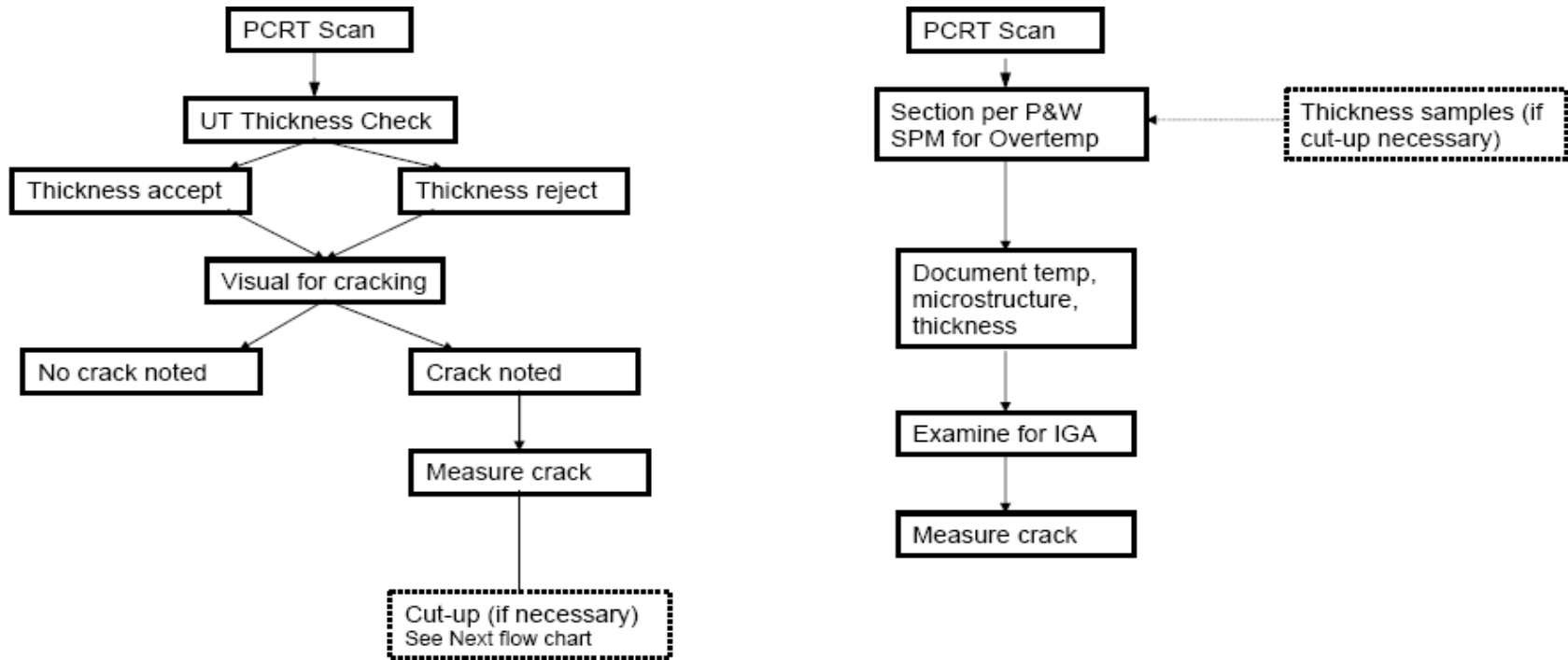

Well thought out plan of attack

PCRT PROJECT TO DATE

Process Compensated Resonance Testing with Vibrant Corporation fixed nest

- No requirement to coating strip or surface prep
- Eliminates structural integrity suspicions
- Eliminates acceptance of hidden structural defects
- Eliminates IGA concern in Engineering
- Improves inspection methodology and reliability

Status

- Teaching Set of 89 blades of varying conditions
- Custom Automated Nest with transducer alignment tool built
- Initial Sorting Module developed
 - Sorting Module is being updated as results are confirmed
- Delta employee trained on using PCRT System for data collection and provided with detailed Work Instructions
- Vibrant continues to support to ensure proper data collection



PCRT project is progressing – 6 month on-site trial

PCRT PROJECT TO DATE CONT.

Status cont.

- UT Inspection of teaching set performed
- Part inspection in progress – over 800 blades scanned
 - Blades failing PCRT are being quarantined for further analysis
- POD study in progress, per test plan
- Several blades have been validated
 - PCRT has failed blades that Materials Lab passes
 - PCRT has passed blades that Materials Lab fails
 - Working on the details
 - Metallography results are highly subjective

Cost-Benefit

- Drastically reduce inspection time, while improving blade reliability
 - PCRT takes seconds and can test all 64 blades vs. Materials Lab taking 70+ hours to inspect a single blade
 - Risk of throwing-away good blades is reduced
 - Risk of putting a potentially bad blade back in to service is greatly reduced



Project off to good start

VIBRANT INTERNAL PCRT OVERTEMP STUDY

- Internal Vibrant study
 - JT8D 3rd stage turbine blade
 - Various temperature exposure
 - Peak shift, relative spacing change (gamma prime solutioning)
 - New peaks created, some peaks disappear
- Capability for microstructure change shown

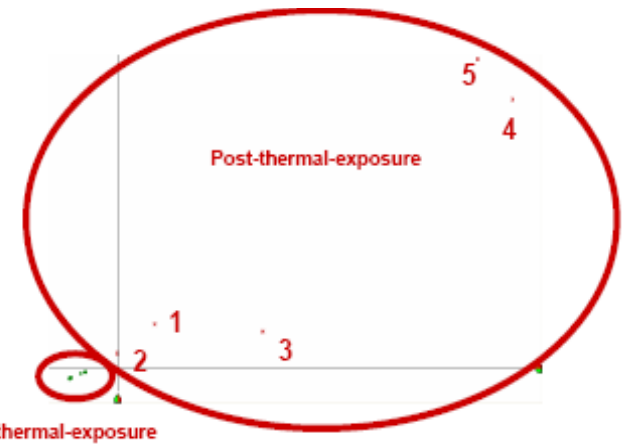
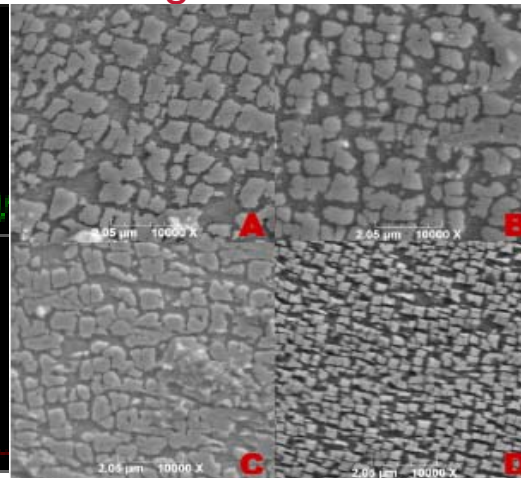
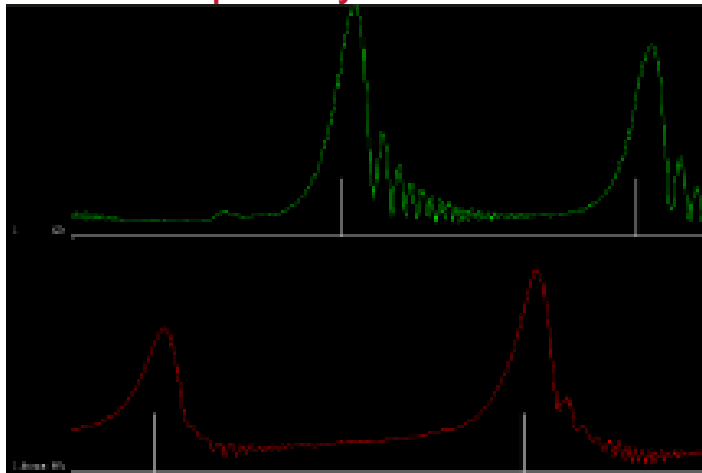
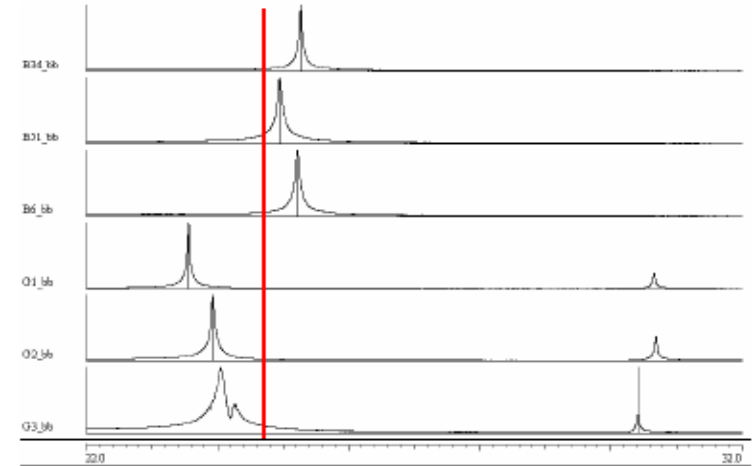

PCRT has shown capability to sort based on overtemp criteria

P&W SPM OVERTEMP ANALYSIS

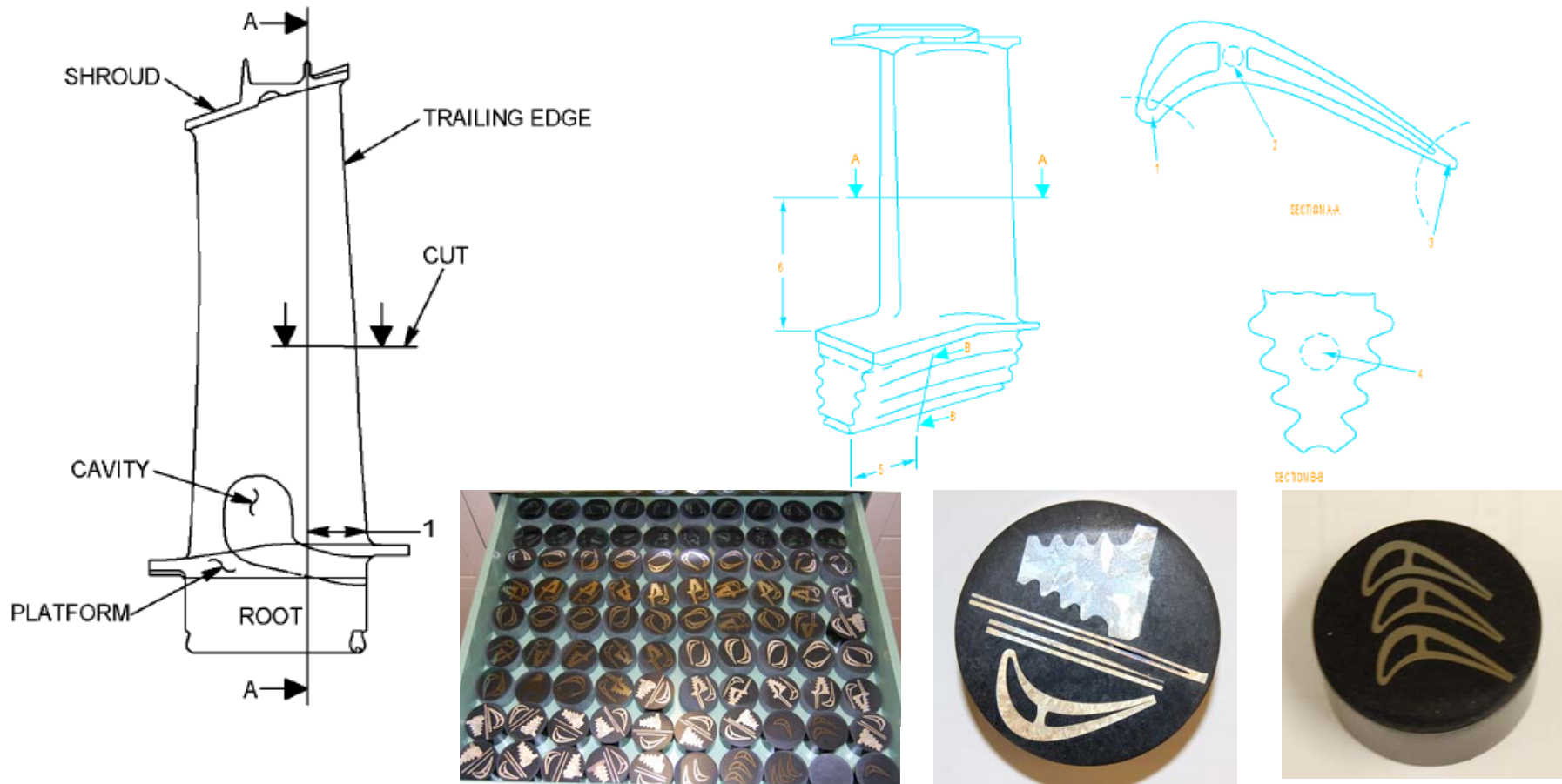

P&W Overtemp analysis requires destructive testing of 1 blade to determine disposition of entire blade set

PCRT VS LAB OVERTEMP ANALYSIS

P&W SPM Task 70-36-00-280-107-0

Blade/Vane Temperature:	Blade/Vane Condition
2050°F	Blade/Vane Overtemped

- Blade exhibited rafting, coalescence and rafting of the gamma prime precipitate within parts of the leading edge and in the trailing edge consistent with a blade over-temperature.

Blade/Vane Temperature:	Blade/Vane Condition
Approached 2050°F	Blade/Vane Good

- While there was mild rafting coalescence of the gamma prime precipitate within parts of the leading edge and in the trailing edge of the blade, there was not enough to be considered a blade over-temperature.

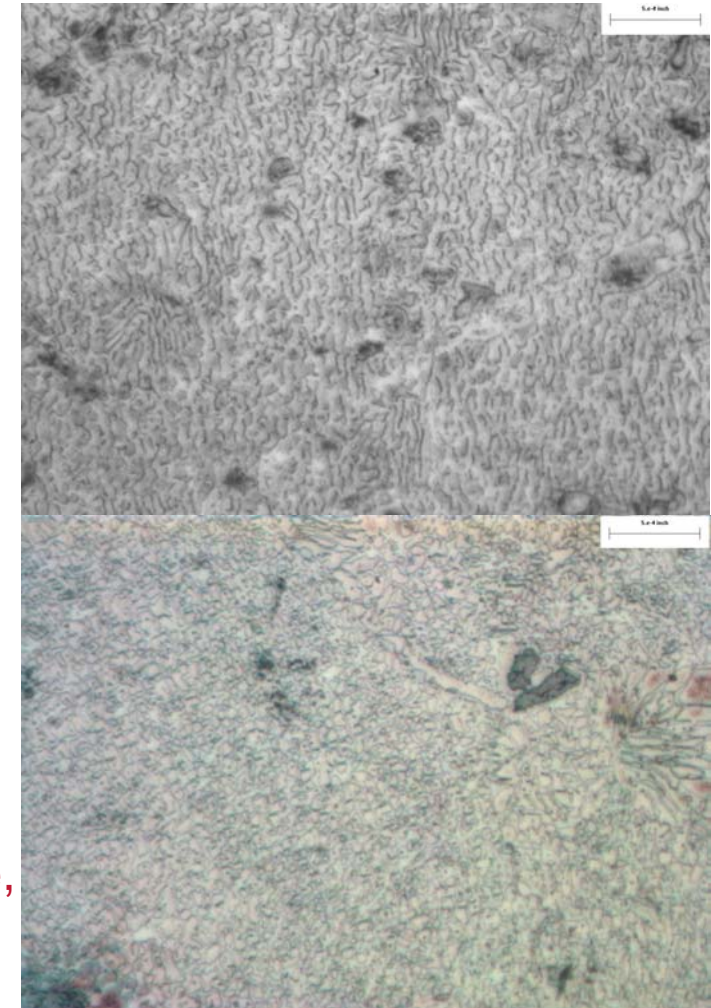

PCRT has shown good agreement with subjective metallography req't

PRELIMINARY RESULTS - OVERTEMP

- In service acceptable = Goods (14)
- Overtemp 2050 F = Bads (5)



PCRT sort for overtemp

PCRT & IGA, STRESS-RUPTURE

- Intergranular attack
 - Stress rupture – stress, temp, time
 - Blockage of cooling passage, contaminants
 - Coating depletion
 - Localized hot spots
 - Strip & recoat repair – internal cavities
 - Practice ceased, modified
 - Recent failures attributed to IGA/stress rupture
 - No inspection for IGA
 - OEM – spare part sales
- Project will quantify degree of IGA
 - Accept/reject Limits

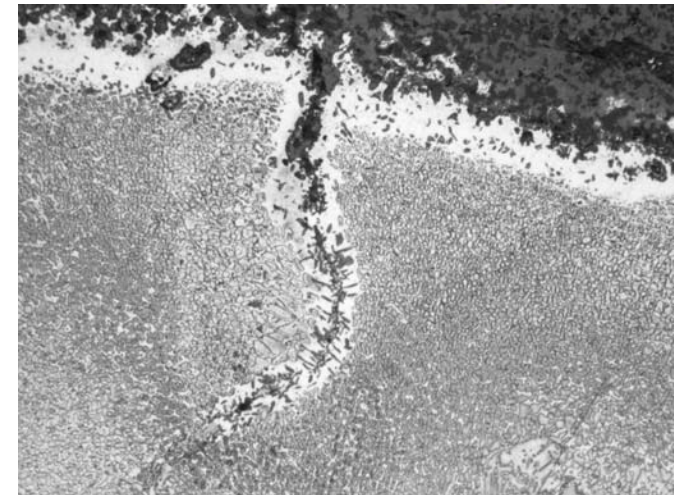
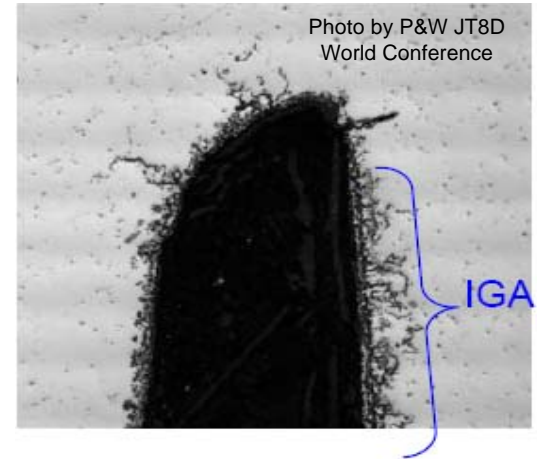

PCRT has shown capability to detect IGA

PRELIMINARY RESULTS – IGA

- In service acceptable = Goods
- 2+ stripped (suspect IGA) = Bads

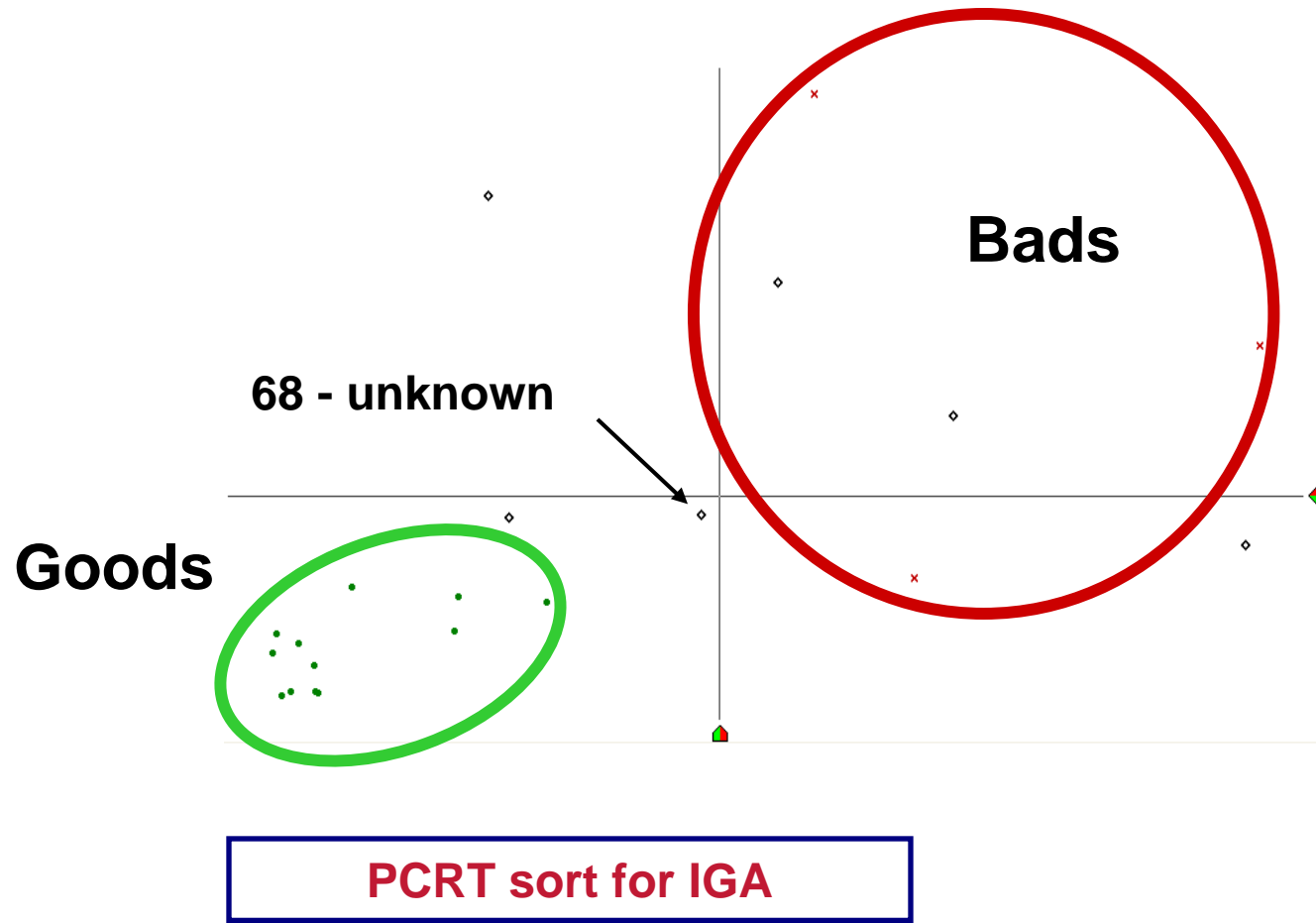

PCRT & CRACKING, THIN WALL

- Cracking typically on trailing edge
 - IGA cracking
 - Thin wall (parent metal removal with stripping)
 - Some blending operations
 - UT Thickness check
 - Revision coming soon from P&W
 - On-wing borescope findings
 - UERs = \$\$\$\$

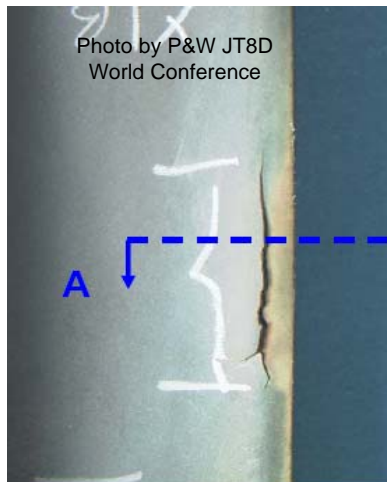

Thin Wall Condition

PCRT has shown capability to detect cracking, thin wall

PCRT & CRACKING, THIN WALL

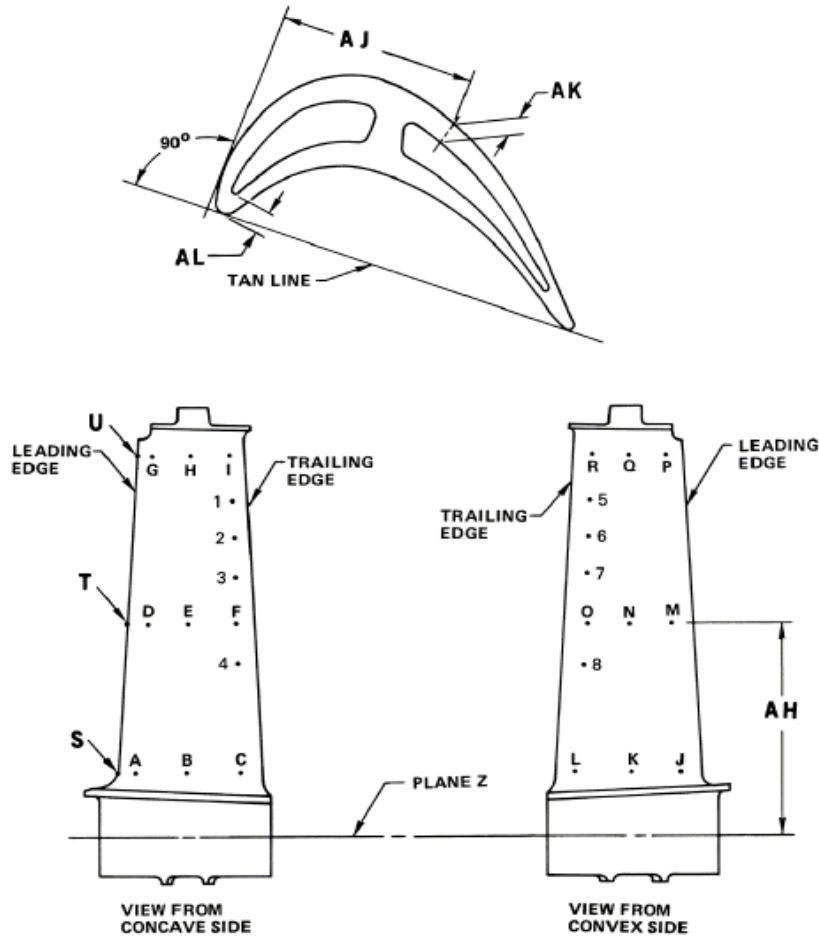

PCRT has shown capability to detect cracking, thin wall

PRELIMINARY RESULTS – THIN WALL

- In service acceptable = Goods
- Cracked/thin wall = Bads

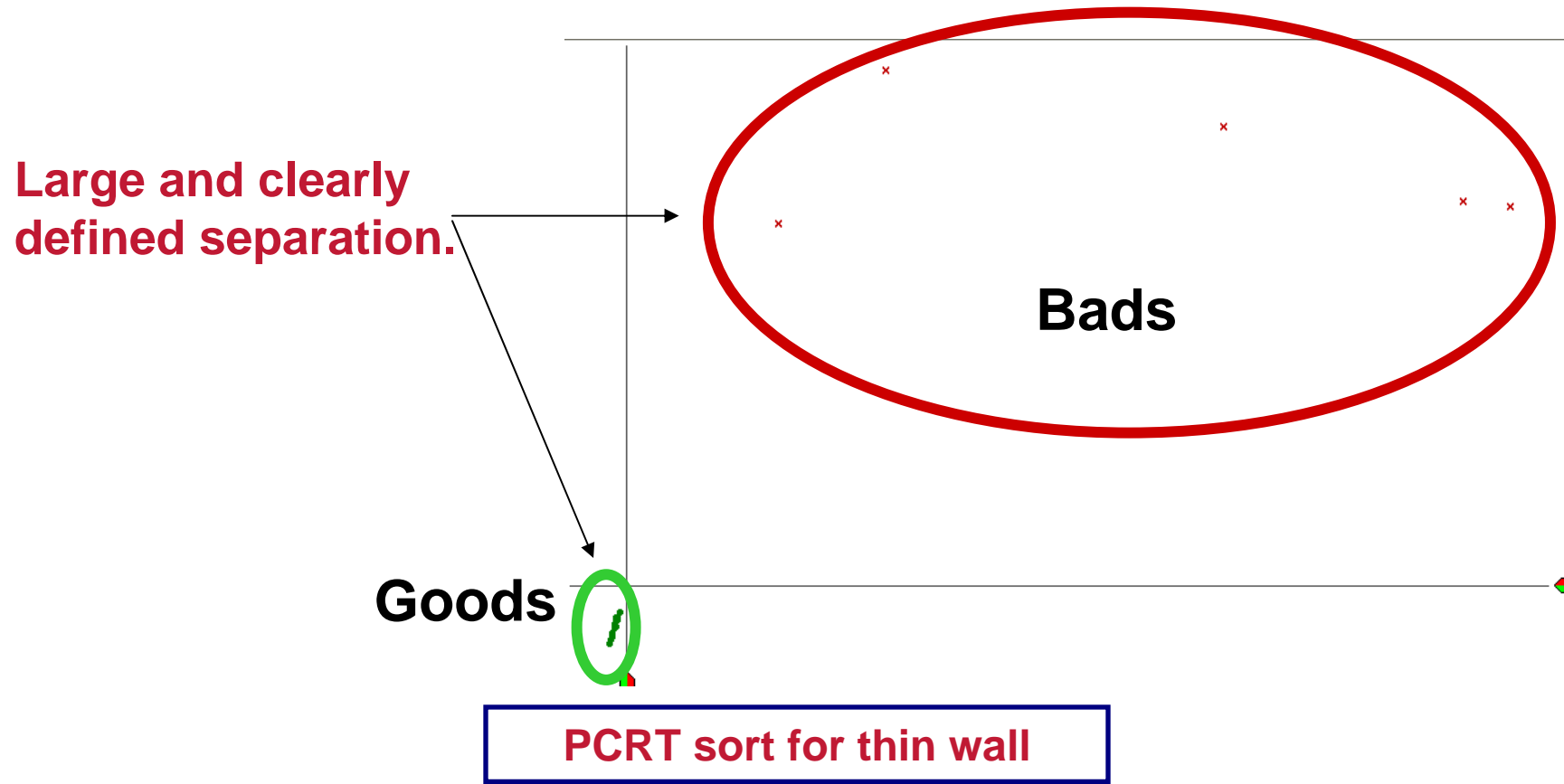

PRELIMINARY RESULTS - COMBINED

- Reduces robustness of PCRT System, however also reduces sorting time.
 - Only need to perform one check for all defects

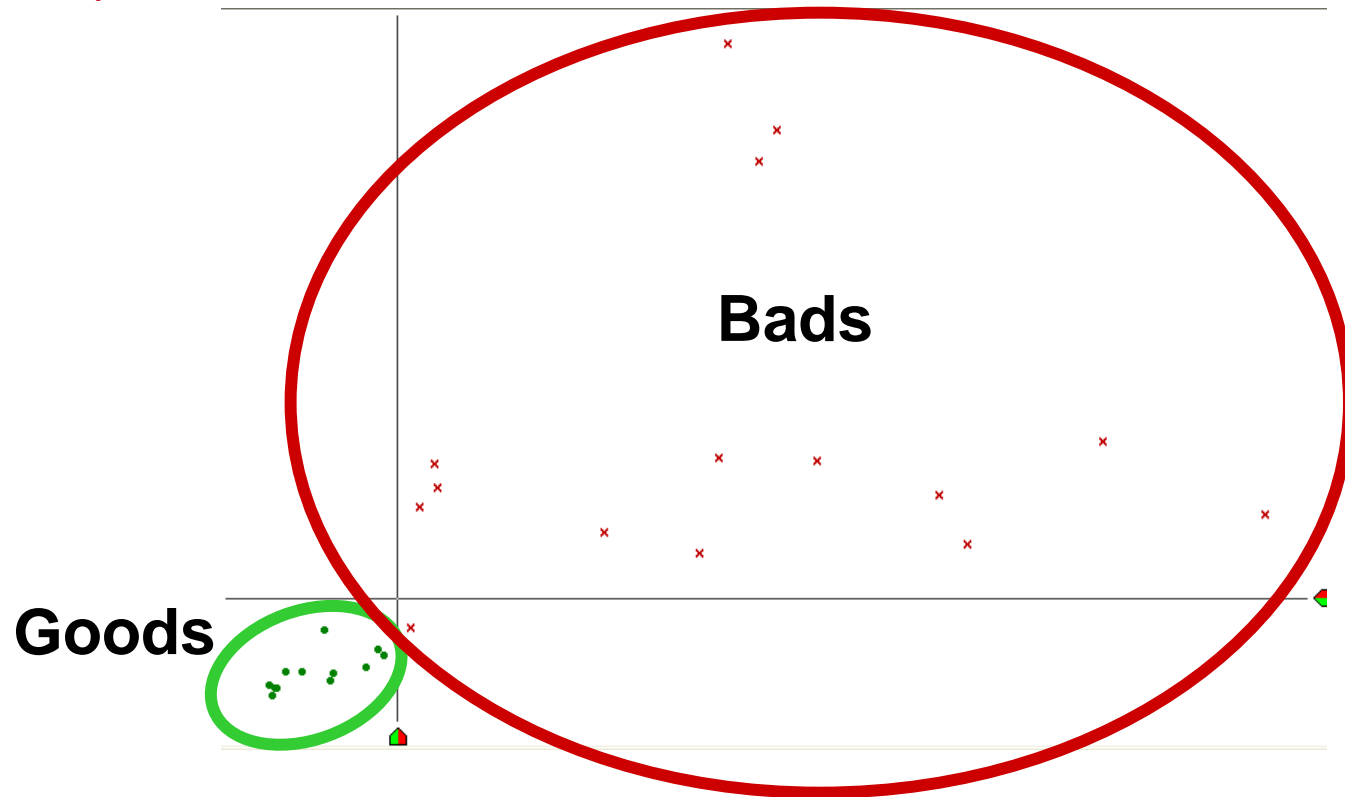

PCRT sort for overtemp, thin wall/cracking, and IGA

WORK TO BE DONE

Process Compensated Resonance Testing on JT8D 1st Stage Turbine Blades

- Continue to collect spectra on blades as they come in to the shop
 - Further develop sorting algorithm
- Continue to validate PCRT System with Metallography and other inspection results
 - Increase confidence in data
- Refine DOE Matrix of defects to possibly reduce the amount of data needed
- Develop POD curves for each of the defects to be tested for
 - Overtemp
 - Thin Wall/Cracking
 - IGA
- Implement a method of uniquely identifying blades (serialization/tracking)
- Validate PCRT System with a blind set



Development, validation to be completed

FINANCIAL GOODNESS EXAMPLE

OVERTEMP SCENARIO

- Assume 25 JT8D overtemp events per year; 80% rejected with cut-up; only 60% rejected with PCRT
- 5 additional blades sets saved with PCRT; Plus labor savings per event (lab)
- $\$2800 \times 64 \text{ blades} \times 5 = \$896,000$
- **TOTAL Savings > \$900,000 on an annual basis**

REPLACEMENT SCENARIO

- $\$2800 \times 64 \text{ blades} \times 117 \text{ aircraft} \times 2 \text{ engines} = \sim \42M material cost for blade replacement
 1. Does not include labor, transportation, cleaning, inspection, test cell, etc

UER SCENARIO

- 12 UER since Jan 2007 for turbine blade issues (other than OT indication)
 - Cost for visit after UER approaches \$500,000 material cost
 - Does not include labor, transportation, cleaning, inspection, test cell, etc

Financial benefit has substantial potential

SUMMARY

Implementation of Process Compensated Resonance Testing provides:

- Significant cost savings for Delta
 1. Reduces need to purchase new blades
 2. Increased reliability – reduces UER, IFSD
 3. Use of technology for several defects with one inspection
 - Overtemp Analysis
 - Thin Wall
 - Intergranular Attack
 - Cracking

Accomplished:

- Feasibility study, nest manufactured
- Mid-way through 6-month on-site trial, plenty of data collected

Work to do:

- Complete metallurgical validation
- Revise PCRT algorithm based on results
- Implement inspection

